

SUPERPLAN XXL

- exclusive, elegant design
- generous dimensions ideal for showering with a friend
- shallow depth ideal for floor level installation and guarantees easy access
- made of KALDEWEI steel enamel
- flush-fitting recessed waste cover
(only in combination with the KA 90 waste fittings)



Similar illustration

Modell	Combined Tray & Waste depth				Waste fitting depth			
	447	439	442	431	447	439	442	431
KA 90	120	123	123	115	81	81	81	81
KA 90 extra flat	109	112	112	108	70	70	70	70
KA 90 ultra flat	100	103	103	99	61	61	61	61
KA 90 vertical	49	49	49	49	81	81	81	81

See page 275.

Model 447 with support

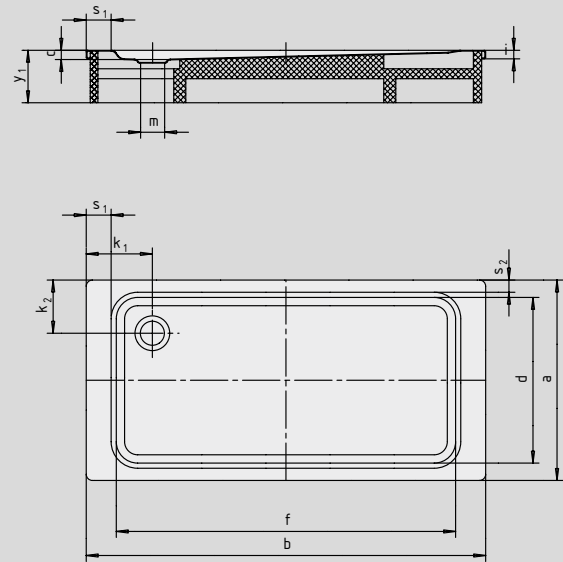

Model No.	447	439	442	431	
External length	a	800	900	1000	700 mm
External width	b	1500	1500	1500	1600 mm
Depth	c	40	43	43	39 mm
Internal length	d	640	790	890	590 mm
Internal width	f	1300	1290	1290	1290 mm
Height of rim	i	32	32	32	32 mm
Distance tray edge to centre of drain hole	k ₁ ; k ₂	250; 225	250; 200	250; 200	300; 200 mm
Diameter of drain hole	m	90	90	90	90 mm
Width of rim	s ₁ ; s ₂	100; 75	100; 50	100; 50	150; 50 mm
Height with support	y ₁	135	135	135	135 mm
Weight of the enamelled shower tray in kg		31	35	38	29
Anti-slip		300 x 856	856 x 549	856 x 549	856 x 300 mm
Full anti-slip		524 x 1177	649 x 1177	773 x 1177	461 x 1177 mm

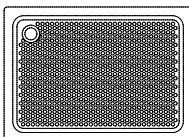

The TÜV Rheinland confirms the following properties of KALDEWEI's anti-slip and full anti-slip finish:

- Assessment group **B** for wet barefoot areas (**DIN 51097**)
- Assessment group **R 10** for slip-resistant properties in work rooms and areas with an increased risk of slipping (**DIN 51130**)